

部材表

平面図

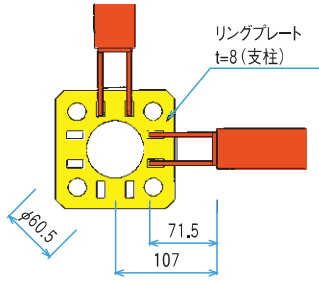

立面図

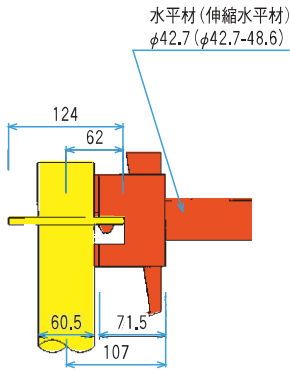

支柱 (φ60.5) (材質: STK500)

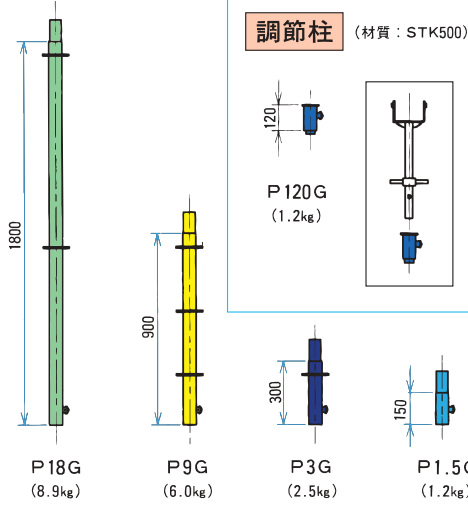

水平ブレース (材質: STK400)

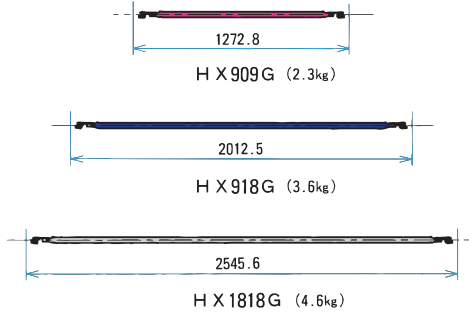

水平材 (材質: STK500)

※600、1200、1500タイプ
在庫制限有り

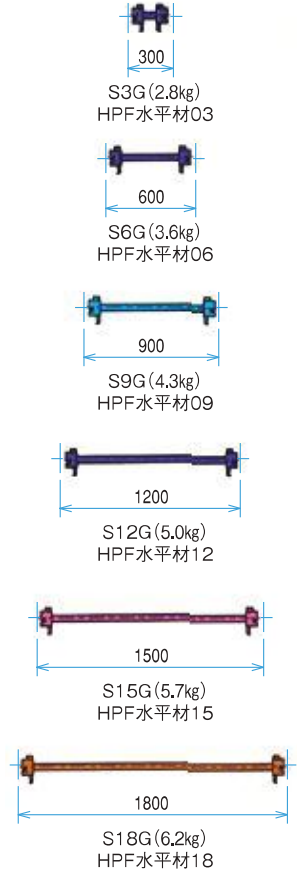

中央集中3kN可

鉛直ブレース (材質: STK400)

グラビティピン径 φ20

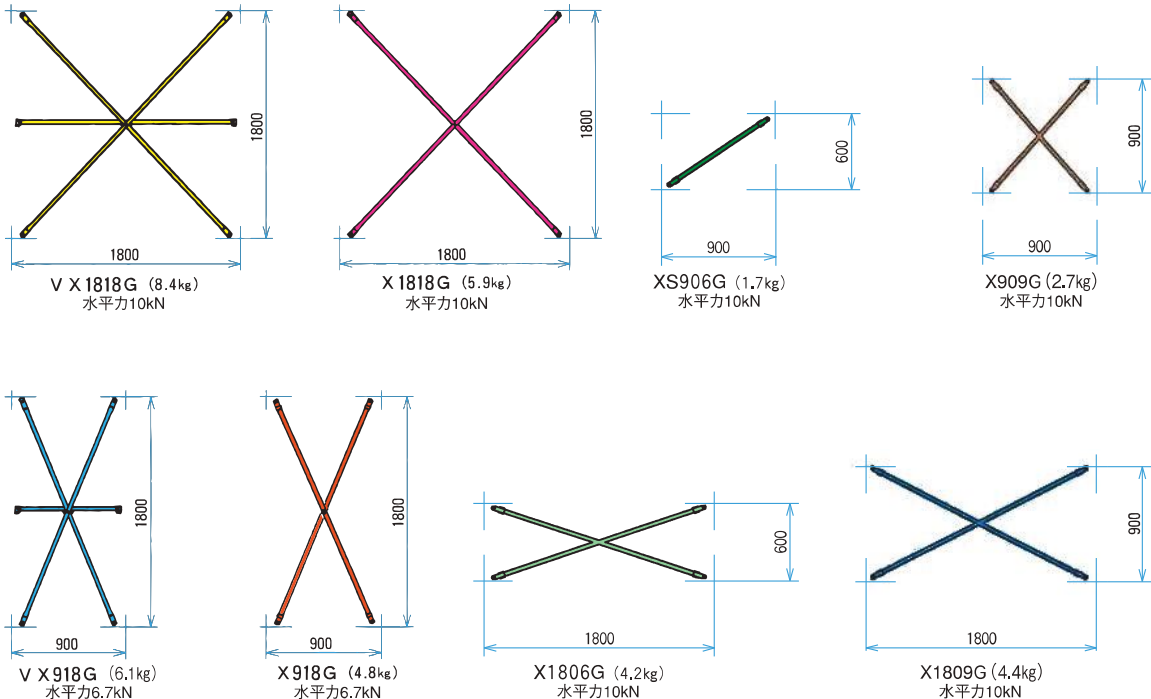

伸縮水平材 (材質: STK500)

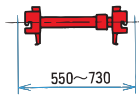

SS507P (4.3kg)
HPF伸縮水平材507

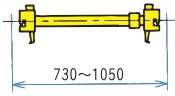

SS710P (5.2kg)
HPF伸縮水平材710

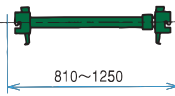

SS812P (5.5kg)
HPF伸縮水平材812

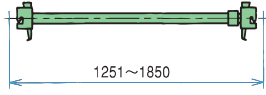

SS1220P (7.5kg)
HPF伸縮水平材1220

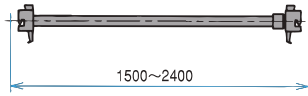

SS1524P (8.4kg)
HPF伸縮水平材1524

ブラケット (材質: STK500)

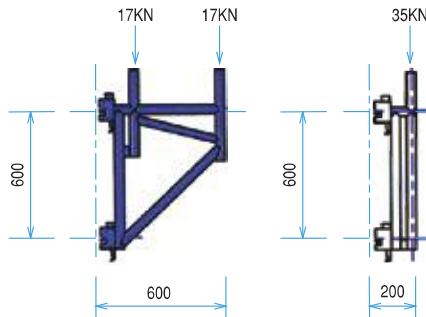

BK6G (9.3kg)
HPFブラケットBK6

BK2G (6.4kg)
HPFブラケットBK2

※内側のみ使用は37kN

補助支柱

(材質: STK500)



P05G
(0.8kg)

取付例

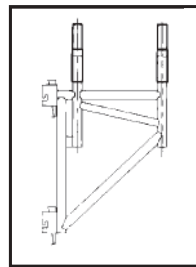

自在梁下枠 (材質: STKR400)

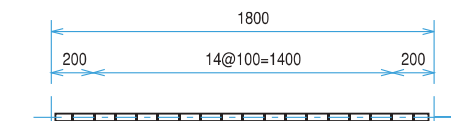

HF18G (24.2kg)
HPF自在梁下枠H18G

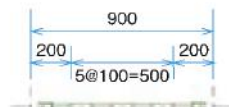

HF09G (15.2kg)
HPF自在梁下枠H09G

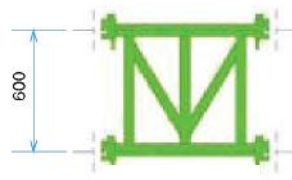

自在梁下枠サポート (材質: STK500)

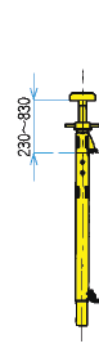

HS0208G
(9.6kg)

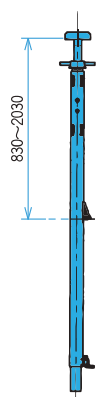

HS0820G
(13.9kg)

Tジョイント



HT600G (4.3kg) 許容支持力 30kn
HPFTジョイント

【許容荷重】

HS0208G - 中間補強無 ($l \leq 700$) 30kN/本
中間補強有 ($l > 701$) //

HS0820G - 中間補強無 ($l \leq 1000$) 25kN/本
中間補強有 (//) 30kN/本
中間補強有 ($l > 1001$) //

足場ブラケット

(材質：STK500)

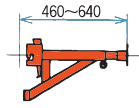

SBK35G
(3.5kg)

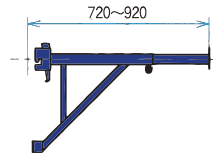

BKSS0609G (5.0kg)
(LBK609G)

先端クランプ付有りも可能

鋼製布板

(材質：SGC-400Z)

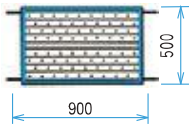

L09PC (7.4kg)
HPF布板09PC

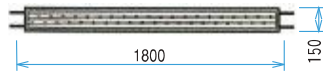

L15×18 (6.5kg)
HPF布板15×18

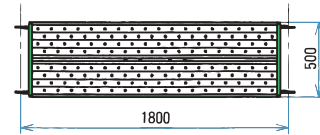

L18P (14.5kg)
HPF布板18P

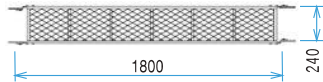

HSN-624 (9.3kg)

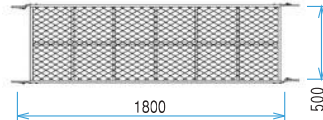

HSN-6 (15.3kg)

型式	L	重量 (kg)
HSN-624	1800	9.3
HSN-524	1500	7.5
HSN-424	1200	6.2
HSN-324	900	5.2

型式	L	重量 (kg)
HSN-6	1800	15.3
HSN-5	1500	12.5
HSN-4	1200	10.3
HSN-3	900	8.3

すきまメッシュ

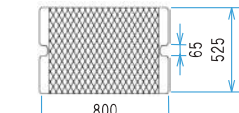

すきまメッシュ68-80 (3.0kg)

スキマ板

(材質：XS43)

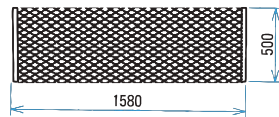

L5014G (7.4kg)
HPFスキマ板14

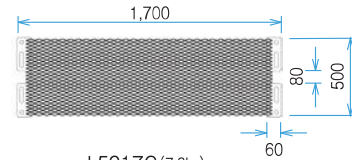

L5017G (7.8kg)
HPFスキマ板17

すき間ステップ

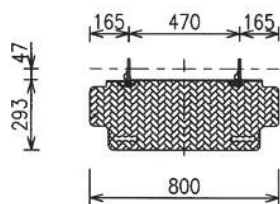

SK09 (7.0kg)
すき間ステップ09

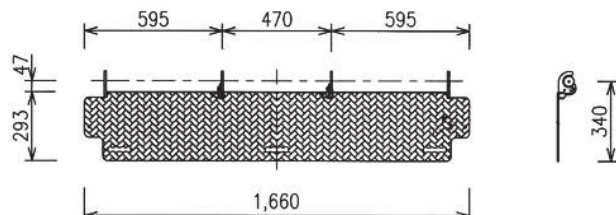

SK18 (15.0kg)
すき間ステップ18

ハンチサポート

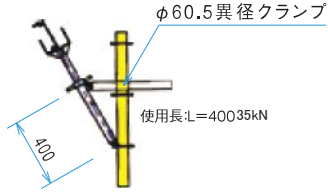

HHS4P (2.8kg)
HPFハンチサポート

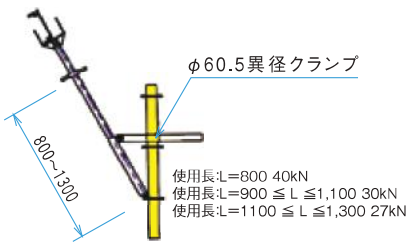

HHS813P (6.0kg)
HPF伸縮ハンチサポート

階段 (材質: STK400)
(材質: アルミ)

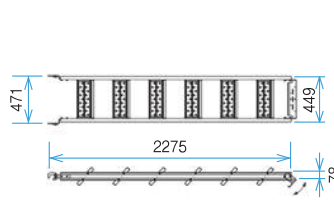

SPカイドン (10.5kg)
(VKSP)

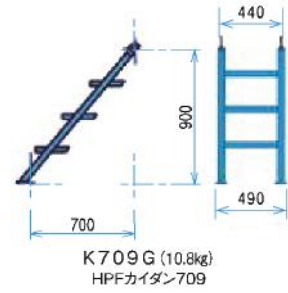

K709G (10.8kg)
HPFカイドン709

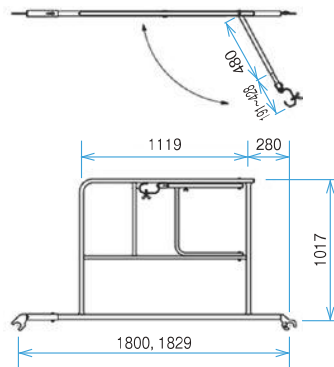

SPセーフティガード (12.0kg)
(ASGSP)

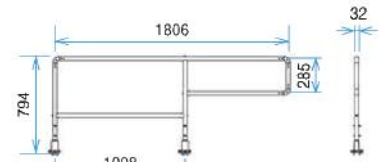

SPカイドン手摺 (4.2kg)
(VKTSP)

大引受ジャッキ

(材質: SS400)

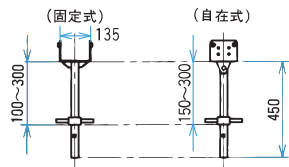

ON35×450P (5.5kg) (ON3545)

ONF35×450P (5.8kg) (ON3545F)

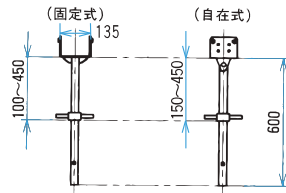

ON35×600P (6.3kg) (ON3560)

ONF35×600P (6.8kg) (ON3560F)

大引 (材質: A6N01)

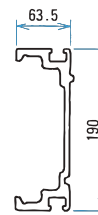

- PF-OA3L700 (5.1kg) (オレンジ)
- PF-OA3L1000 (7.3kg) (ピンク)
- PF-OA3L1100 (8.0kg) (黒)
- PF-OA3L1500 (10.8kg) (水色)
- PF-OA3L2000 (14.5kg) (黄)
- PF-OA3L2500 (18.1kg) (緑)
- PF-OA3L3000 (21.7kg) (茶)
- PF-OA3L4000 (28.0kg) (オレンジ)

ジャッキベース

(材質: SS400)

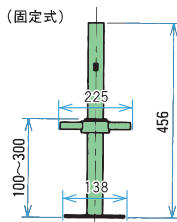

N37×450G (5.8kg)
(N3745)

大引ジョイント

(材質: A6N01)

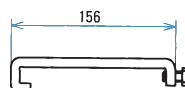

OJ (0.2kg)

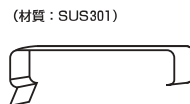

OJS (0.1kg)

大引固定金具

(材質: SS400)

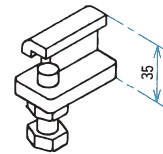

OKK (0.2kg)